

The power behind competitiveness

Delta UPS - Modulon Family DPH Series, 25 - 800 kW

The modular UPS ideal for medium-sized datacenters



Table of Content

Introduction	02
Product Overview	04
Management System	09
Technical Specification	10





Introducing the next generation of modular uninterruptible power supply systems (UPS systems) designed for ultimate availability, excellent performance and high efficiency ideally suited for medium-sized datacenters.

IT operations are a crucial aspect of most business operations. One of the main concerns of datacenters is operational continuity. The most stringent datacenters require the highest availability possible to sustain mission critical functions, the backbone of business continuity. As data keeps growing and rising energy costs are the norm, datacenters will continue to be power hungry facilities. From a capital investment perspective, maintaining high efficiency and having the flexibility to rightsize a datacenter is a critical concern. The Modulon DPH is a modular UPS ideal for medium-sized datacenters demanding in peak efficiency and availability at a lower Total Cost of Ownership (TCO).

- 1) Fully fault-tolerant design to meet strict requirement on availability due to increased IT-dependent business operation
- 2) Scalable flexibility to rightsize the infrastructure at the right time without overinvestment
- 3) Industry leading power performance and efficiency to save energy cost that reduce the operational expense

The Modulon DPH is in a dimension of 19" enclosure providing rack-based agility to datacenter space arrangement and infrastructure setup. As a powertrain of datacenters, the Modulon DPH can integrate the power distribution in a same rack or through the deployment of paralleled rack enclosure depending on the power capacity requirement, a perfect combination of power protection and distribution to streamline the power management in the datacenters.



The Modulon DPH is designed in modern IT aesthetics aligned with Delta InfraSuite datacenter solutions.



Product Overview

Ultimate Availability

- Advanced fault-tolerant design achieved by self redundancy to guarantee operation continuity
- Self-synchronization of power and control modules for continuous on-line operation even in the event of control module failure to avoid downtime caused by single point failure
- Hot-swappable key modules and components to ensure Mean Time To Repair (MTTR) close to zero without downtime risk
- Wide input voltage range of -45% to +25% and narrow output voltage regulation window to cope with harsh utility conditions and seamlessly provide stable power supply to the load
- High overload protection to support 125% overload for 10 minutes and 150% for 1 minute

High Scalability

- Vertical expansion from 25kW to 200kW supporting N+X redundancy in a single rack enclosure to save footprint
- Parallel expansion up to four units without requiring additional hardware
- Variable configurations possible providing the scalable flexibility up to Tier 4 standard

Excellent Power Performance and Efficiency

- Fully rated power (kVA=kW) to maximize power availability
- High AC-AC operating efficiency of 95% at 30% light load and 96% from 50% load resulting in marked energy cost savings
- Low harmonic pollution (iTHD<3%) to reduce upstream investment costs and meet demanding power requirements

Easy Maintenance

- Built-in manual bypass to eliminate maintenance-related downtime
- Proactive detection of fan failure and switch fault for early diagnosis on UPS malfunction
- Plug and play to simplify the maintenance process

Applications



Datacenter



Telecom



Industrial



Network



Security



Lab



Medical



Metro



Banking



The Modulon DPH supports ultimate availability to ensure the continuity of mission critical operations.

Ultimate Availability for Mission Critical Operations

The datacenter constitutes the critical load in the daily operations of the organization. Cost of downtime due to critical load failure is extreme and runs between USD4,000 to USD6,000 per minute or even more. To achieve the highest availability possible for the datacenter, it is vital for the most reliable products or solutions supported by the shortest or even zero Mean Time To Repair (MTTR).

The fully fault-tolerant design provides self redundancy to the control mechanism, cooling and power modules. Full control logic allows the system to self-synchronize in the event of main module failure and automatically switch to the backup for assured continuous operation.

Furthering the advantages, the hot-swappable functionality of critical components and modules improve the serviceability of the UPS system thereby reducing MTTR close to zero to assure maximum uptime and ultimate availability in the datacenters.

As illustrated, the Modulon DPH can run under inverter mode and bypass mode to sustain uninterruptible power supply to critical load:

In the event of STS module removal, the Modulon DPH still functions under inverter mode (normal mode without bypass utility backup). During failure in normal mode, such as over temperature, overload, short circuit, abnormal output voltage, or low battery, the Modulon DPH smoothly transfers over to bypass mode.

In addition, the Modulon DPH has a wide input voltage range of -45% to $+25\%$ and narrow output voltage regulation window to cope with harsh utility conditions, seamlessly providing stable power supply to the load. In the event of overload, the Modulon DPH supports 125% overload protection for up to ten minutes and one minute at 150%.

The Modulon DPH assures exceptional reliability and maximizes uptime to deliver six-nines availability contributing to the best-in-class practice to reduce Total Cost of Ownership (TCO).

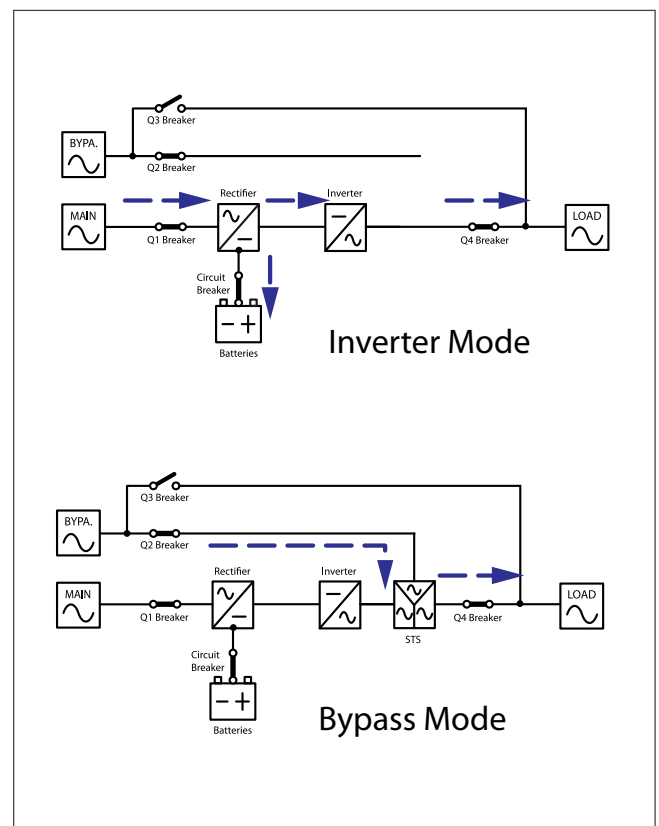



Modularity Designed for Scalability

Scalable architecture allows you to optimize cost expenditure to meet your power demands and deliver uninterrupted services in line with the business growth without over-sizing the power capacity.

The plug and play design of power module supports vertical and horizontal expansion of power capacity at the right time with the right investment. In the situation of a single rack enclosure, the system can vertically scale from 25kW to 200kW and achieve N+1 or N+X

redundancy in the same rack. As business demands grow, the flexibility of the Modulon DPH allows for parallel expansion of up to four units without requiring additional hardware.

The Modulon DPH offers the advantages you need without the high initial investment costs or sacrificing power capacity so as not to create investment excess due to capital waste.

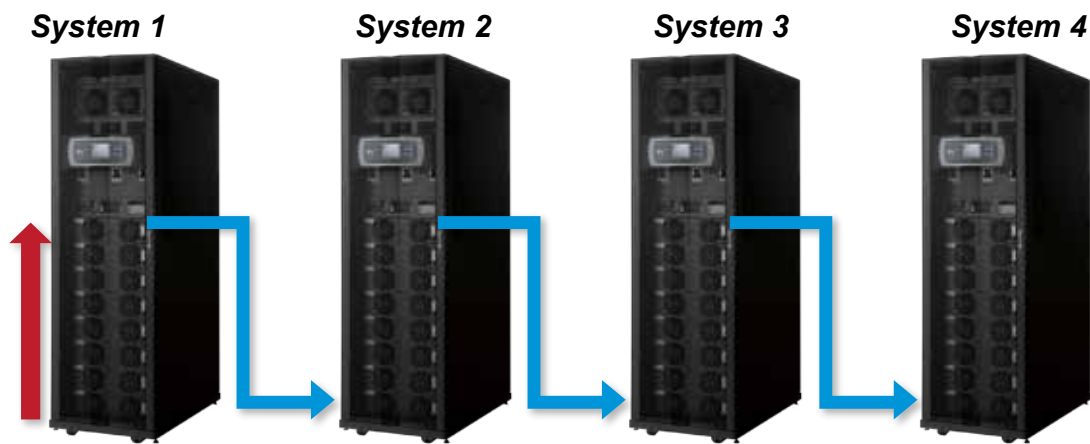

VERTICAL MODULARITY

from 25 to 200 kW

- On-site upgradable to 8 power modules within a rack
- Hot-scalable

HORIZONTAL MODULARITY

up to 800kW

- Parallel expansion up to 4 units
- Easy connection by parallel wire



Excellent power performance and efficiency directly translate into significant reduction of operational costs.

Excellent Power Efficiency and Performance

Two key trends have developed in the world of datacenter operations – demand for power and the cost of that power. Today’s management is facing growing pressure to optimize performance for sustainability and growth.

Delta’s UPS solutions deliver one of the highest power performance and efficiency ratings available while reducing cost. The Modulon DPH delivers fully rated power (power factor=1, kVA=kW) providing the maximum power capacity to the load. Compared to UPS systems with output of PF=0.8 and PF=0.9, the DPH supplies 25% and 11% more power, respectively. Other than that, the fully rated power factor is supported by a “stronger” inverter design providing better power protection and quality to loads.

The Modulon DPH demonstrates excellent power performance with low total input harmonic distortion (iTHD<3%). Its reduced load pollution increases power quality, optimizes generator sizing to increase your investment savings, reduces installation costs, and extends the life of valuable equipment.

The Modulon DPH features excellent AC-AC efficiency up to 96% at half load and places itself among the highest in its class. In addition to energy saving, higher efficiency levels also mean less heat dissipation, giving way to lower cooling costs.

Excellent power performance and efficiency lower operation costs significantly. The Modulon DPH combines these benefits to provide high performance, efficient power protection to maximize operational savings for any datacenter.

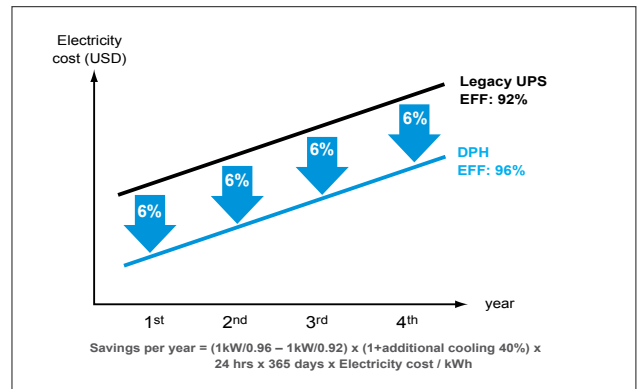
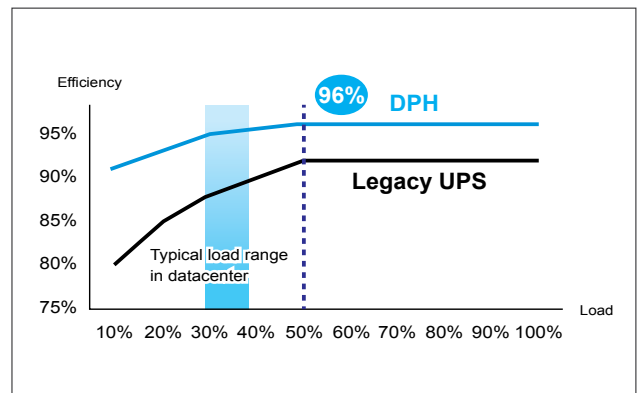
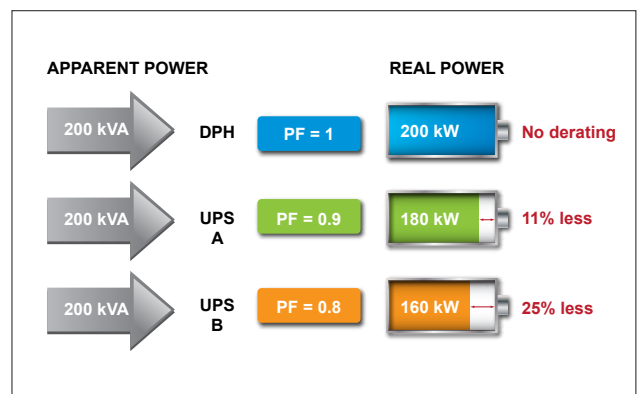

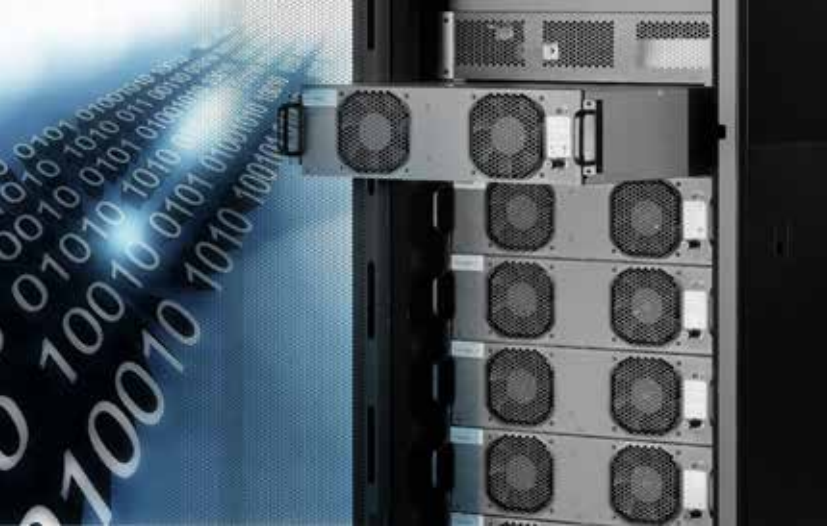

Hot plug and hot swap simplify the maintenance process.

Easy Maintenance

The Modulon DPH hot plug and hot swap architecture makes best use of a modularity design for 50% faster time of repair compared to traditional UPS systems. Plug and play modularity also eliminates the risk of second fault occurrence caused by complex failure checking and removing processes. The reliability of maintenance and service is guaranteed, further assuring the system availability.

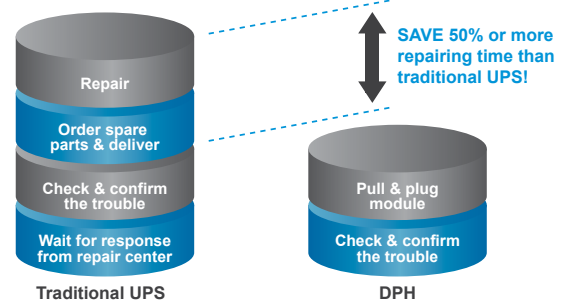

Architecture

Hot-swappable Control Module

Hot-swappable STS Module

Multi-language LCD Control Panel

Output Breaker

Bypass Breaker

Main Input Breaker

Hot-scalable Power Module (up to 8 units)

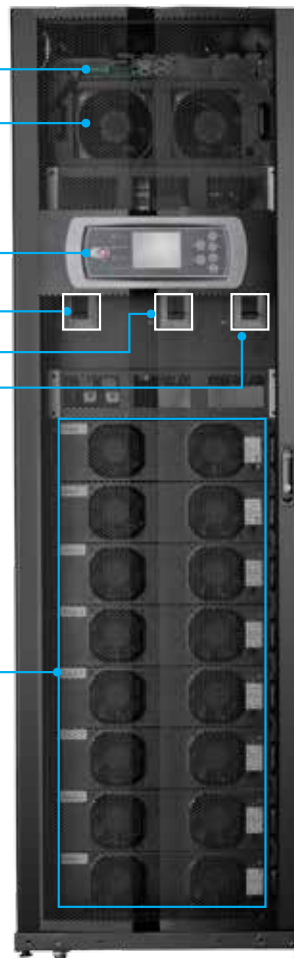



Remote control and monitor datacenter at the tip of your fingers

Management System

User-friendly Control Interface

Designed for management ease, the Modulon DPH is fully equipped with user-friendly monitoring and controls in various languages. A big graphic LCD screen provides the needed control for all communication and command options at the tip of your fingers to monitor and control functions on a single page view. Direct event log viewing helps quickly diagnose events without additional hardware requirements. Up to 3,000 event logs can be recorded.



Integrated Monitoring and Management

Delta UPSentry 2012 communicates with UPS through physical interface RS232 and USB for UPS manageability. Also works with Shutdown Agent 2012 to protect a group of PCs, workstations, or servers. Delta New Shutdown Agent cooperates with SNMP card or UPSentry 2012 to shut down multi-servers in various operating system and virtual machine gracefully to prevent possible data corruption. Furthermore, Modulon DPH can be monitored and controlled together with other datacenter equipment by Delta InfraSuite Manager (EMS 3000) as a total datacenter control and monitoring solution.

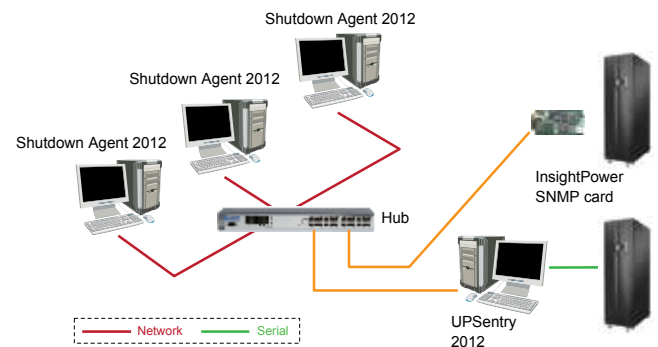

Intelligent Battery Management System

Delta intelligent battery management system can sustain battery lifespan and the capacity of battery backed up through the functions of:

- Battery temperature monitoring & compensation
- Battery remaining capacity displayed in percentage
- Overcharge/discharge protection
- Boost/float stage charge
- Auto/manual battery test
- Adjustable charging voltage from 254V to 291V adapts to different types of batteries
- Up to 40A charging current even at full load conditions
- 38~42 battery units in one battery cabinet optimizes investment

Technical Specification

Model		DPH							
Power Rating (kVA)		25	50	75	100	125	150	175	200
Power Rating (kW)		25	50	75	100	125	150	175	200
Input	Nominal Voltage	380/220V, 400/230V, 415/240V (3 phase, 4-wire +G)							
	Voltage Range	176~276 / 305~477 Vac *							
	Current Harmonic Distortion	< 3% **							
	Power Factor	> 0.99							
	Frequency	50/60 Hz							
Output	Voltage	380/220V, 400/230V, 415/240V (3 phase, 4-wire +G)							
	Output Power Factor	1 (kVA=kW)							
	Voltage Harmonic Distortion	≤ 2% (linear load)							
	Voltage Regulation	± 1% (static)							
	Frequency	50 or 60 Hz							
	Frequency Regulation	± 0.05 Hz							
	Overload Capacity	≤ 125%: 10 minutes; ≤ 150%: 1 minute							
Interface	Standard	Parallel port x 2, Smart slot x 2, Dry contact output x 6, Dry contact input x 6, Battery dry contact x 6							
	Optional	SNMP card IPv6, ModBus card, Relay I/O control card, EnviroProbe, Battery cabinet temperature sensor, Battery cabinet status cable							
Conformance	Safety & EMC	CE, EN62040-1							
Other Features	Parallel Redundancy and Expansion	Module and system redundancy; Maximum 4 units up to 800 kW							
	Emergency Power Off	Local and remote							
	Battery start	Yes							
	Event Log	3000 records							
	External Battery Cabinet	Optional							
Efficiency	AC-AC	96%							
	ECO Mode	99%							
Environment	Operating Temperature	0 ~ 40 °C							
	Relative Humidity	0 ~ 90% (non-condensing)							
	Audible Noise (at one meter)	< 62 dBA							
Physical	Dimensions (WxDxH)	600 x 1090 x 2000 mm							
	Weight	382 kg	414 kg	446 kg	478 kg	510 kg	542 kg	574 kg	606 kg

* When input voltage is 140/242~176/305 Vac, the sustainable loading is from 60% to 100% of the UPS capacity.

** When input harmonic distortion is less than 1%.

All specifications are subject to change without prior notice.



2007~ 2008 Forbes Asia's Fabulous 50



2009 Frost & Sullivan Green Excellence Award for Corporate Leadership



Delta's Manufacturing System Certified by ISO 9001 and ISO 14001 Standards



IECQ Certificate of Hazardous Substance Process Management



Europe

Czech Republic

Delta Energy Systems (Czech Republic), spol.s r.o.
Perucka 2482/7
120 00 Praha 2
Czech Republic
T +420 272 019 330
F +420 271 751 799

Finland

Delta Energy Systems (Finland) Oy
Juvan teollisuuskatu 15
02921 Espoo
T +358 9 84966 0
F +358 9 84966 100

France

Delta Energy Systems (France) S.A.
ZI du bois Chaland 2 15 rue des Pyrenees,
Lisses
91056 Evry Cedex
T +33 1 69 77 82 60
F +33 1 64 97 05 77

Germany

Delta Energy Systems (Switzerland) AG
German Office
Coesterweg 45, D-59494 Soest
59494 Soest
T +49 2921 987 337
F +49 2921 987 396

Italy

Delta Energy Systems (Italy) S.R.L.
Piazza Grazioli 18
00186 Roma
T +39 06 699 41 209
F +39 06 699 42 293

Poland

Delta Energy Systems (Poland)
Sp. z.o.o. 23 Poleczki Str.
02-822 Warsaw
T +48 22 335 26 00
F +48 22 335 26 01

Russia

Delta Energy Systems (Russia)
Vereyskaya Plaza II, office 503,
Vereyskaya str.17
121357 Moscow, Russia
T +7 495 644 32 40
F +7 495 644 32 41

Slovak Republic

DELTA ELECTRONICS (SLOVAKIA), s.r.o.
Botanická 25/A, SR-841 04 Bratislava,
T +421 (0)2 6541 1258
F +421 (0)2 6541 1283

Spain

Delta Energy Systems (Spain)
S.L. Calle Luis I
nº 60, Nave 1a, P.I. de Vallecas
28031 Madrid
T +34 91 223 74 20
F +34 91 332 90 38

Sweden

Delta Energy Systems (Sweden) AB
P.O.Box 3096
35033 Växjö
T +46 470 70 68 16
F +46 470 70 68 90

Switzerland

Delta Energy Systems (Switzerland) AG
Freiburgstrasse 251
3010 Bern-Bümpliz
T +41 31 998 53 11
F +41 31 998 54 85

Turkey

Delta Greentech Electronic San. Ltd.
Sti. Serifali Mevkii Barbaros Bulvari Söylesi Sok.
No: 19, K1, Y.Dudullu-Umraniye
34775 Istanbul
T +90 216 499 9910
F +90 216 499 8070

United Kingdom

Delta Electronics Europe Ltd.
1 Redwood Court
Peel Park, East Kilbride
G74 5PF
T +44 1355 588 888
F +44 1355 588 889

Middle-East & Africa

South Africa

Delta Energy Systems MEA (Switzerland) AG
South Africa Representative Office
Unit 305B, Lougardia Building,
Cnr Embankment and Hendrik Verwoerd Drive,
Centurion
T +27 12 663 2714
F +27 86 667 0469

Americas

Argentina

Delta Greentech
Sarmiento 1889 5A
Buenos Aires
T +5411 4372 310

Brazil

Delta Energy Systems (Brazil) S/A
Rua Itapeva, Nº 26 - 3º andar
01332 000 - São Paulo - SP
T +55 11 3568 3874
F +55 11 3568 3865

Colombia

Delta Greentech
Calle 213 # 114-10 manzana 14 casa 25
Caminos de Arrayanes
T +57 1 673 4927
F +57 1 673 4927

Asia Pacific

China

Delta GreenTech (China) Co., Ltd.
No.238 Minxia Road, Pudong
P.R.C 201209 Shanghai
T +86 21 5863 5678
+86 21 5863 9595
F +86 21 5863 0003

India

Delta Power Solutions (India) Pvt. Ltd.
Plot No. 43, Sector-35, HSIIDC,
Gurgaon-122001, Haryana, India
T +91 124 4874 900
F +91 124 4874 945

Taiwan

Delta Electronics Inc.
39 Section 2, Huandong Road, Shanhua
Township
Tainan County 74144, Taiwan
T +886 6 505 6565
F +886 6 505 1919